

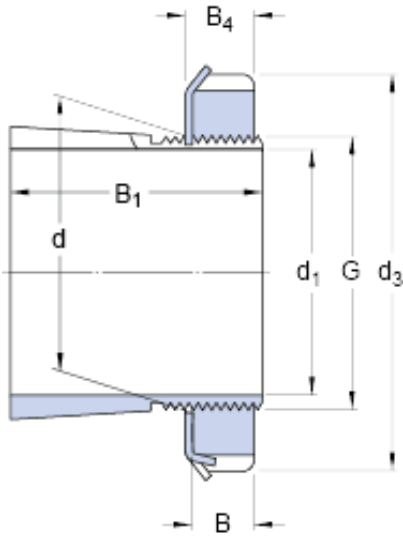

NTA BEARING PRECISION AXLE CORP.



skf SNW 115x2.7/16 Adapter sleeves, inch dimensions

Bearing No. SNW 115x2.7/16

d_1	61.913 mm
d	75 mm
d_3 max.	98.552 mm
B_1	78.08 mm
B	15.342 mm
B_4	16.916 mm
G	74.498 mm
Threads per inch	12
Mass adapter sleeve assembly	1.35 kg
Sleeve	S 115x2.7/16
Hydraulic nut	HMVC 15E

SNW 115x2.7/16 Bearing 2D drawings and 3D CAD models