

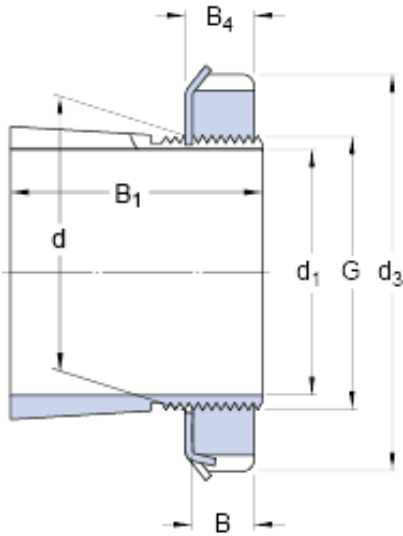

NTA BEARING PRECISION AXLE CORP.



skf SNW 3030x5.1/8 Adapter sleeves, inch dimensions

Bearing No. SNW 3030x5.1/8

d_1	130.175 mm
d	150 mm
d_3 max.	181.102 mm
B_1	88.443 mm
B	24.867 mm
B_4	27.788 mm
G	149.555 mm
Threads per inch	12
Mass adapter sleeve assembly	4.45 kg
Sleeve	S 3030x5.1/8
Hydraulic nut	HMVC 30E

SNW 3030x5.1/8 Bearing 2D drawings and 3D CAD models